



LEWISTON DOOR

ASSEMBLY INSTRUCTIONS



LEWISTON DOOR Recommended Tools

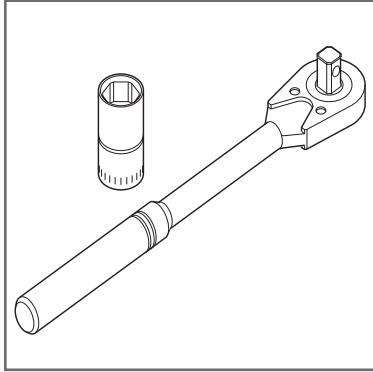

Socket Wrench with
7/16" Socket

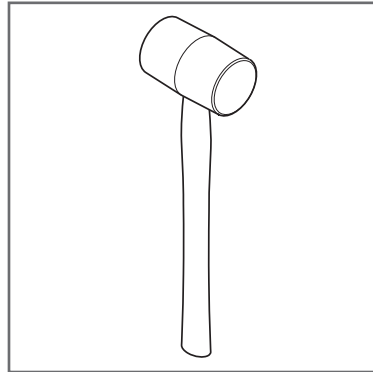

Rubber Mallet

LEWISTON DOOR Parts

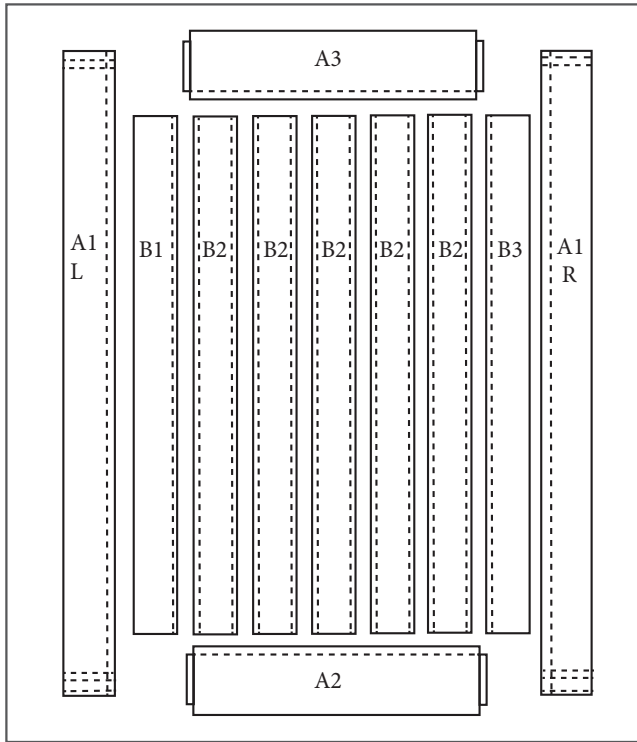

Door Parts

A L Stile	B1 Slat	All B2 Slats	B3 Slat	A R Stile

Slat and Stile End Views

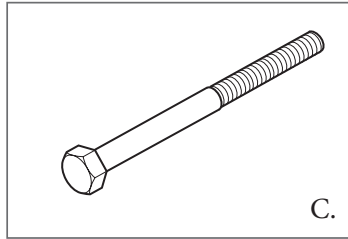

PARTS		QTY
A1 L	Side Stile Left	1
A1 R	Side Stile Right	1
A2	Bottom Rail	1
A3	Top Rail	1
B1	Left Side Slat	1
B2	Middle Slats	5*
B3	Right Side Slat	1
C	6" Lag Bolts	4*

*Quantities will vary depending on door size.

FIRST THINGS FIRST

Lay out all wood parts before beginning assembly to ensure parts have not been damaged in shipping. If damage has occurred, call 800-891-8312 and Rustica Hardware will expedite a replacement.

This door model comes in various sizes. The instructions have been written for the average single door size; but larger doors may have more wood and fastener parts.

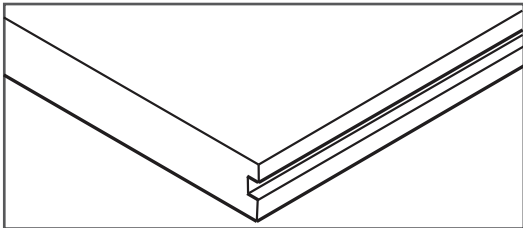
<p>NOTE: Doors using Floor Mount Door Guides will have a groove on the bottom edge. Ensure this groove is on the bottom when hanging the door.</p>	
---	--

USE TEAMWORK - WE RECOMMEND TWO PEOPLE FOR THIS BUILD.

LEWISTON DOOR Assembly Instructions

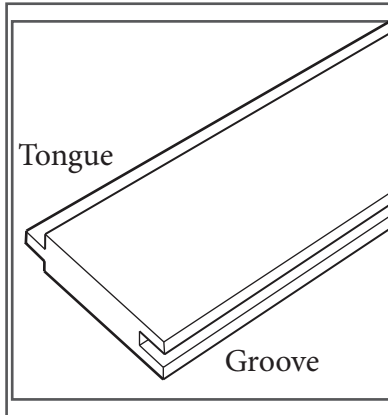

By Definition:

Tongue and Groove

Tongue refers to the ridge extending beyond the main portion of the slat or stile. Groove refers to the slot cut into the other side of the slat or stile.

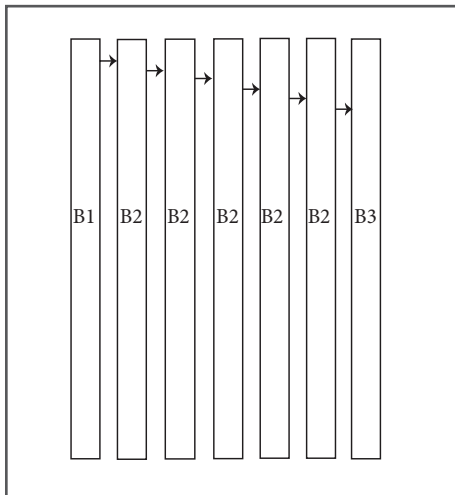

Figure 1

1. On a flat, clean surface, lay out the B1 slat with the tongue facing to the right. Lay all B2 slats next to B1 with the tongue facing to the right. Lay B3 to the right of the last B2 Slat with the groove facing left. Assemble by fitting the tongue into the groove of each piece (Figure 1).

NOTE:

The following should be a 'dry' assembly. Do not use adhesives in when putting this door together.

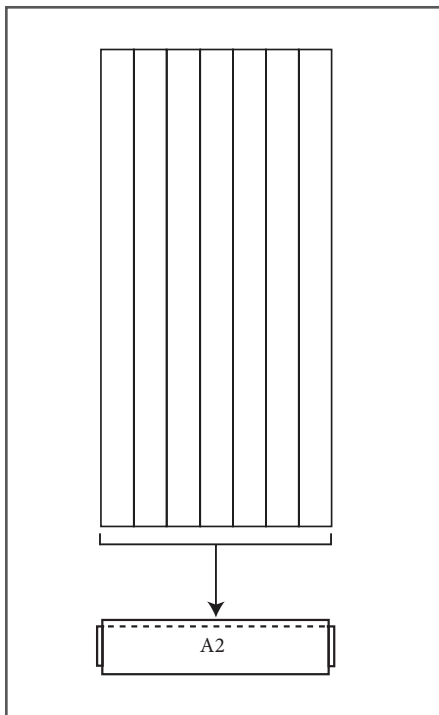

Figure 2

2. Place the Bottom Rail (A2) below the assembled slats. Slide upward to cover the lower edge of the slat assembly. Tap the Bottom Rail into place with a rubber mallet (Figure 2).

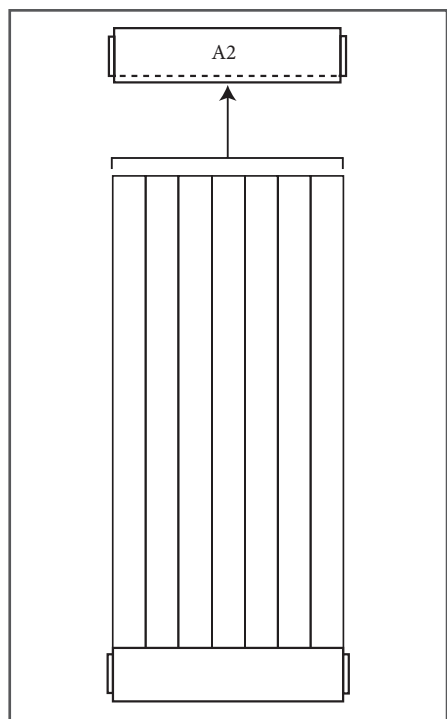

Figure 3

3. Place the Top Rail (A2) above the assembled slats. Slide downward to cover the upper edge of the slat assembly. Tap the Top Rail into place with a rubber mallet (Figure 3).

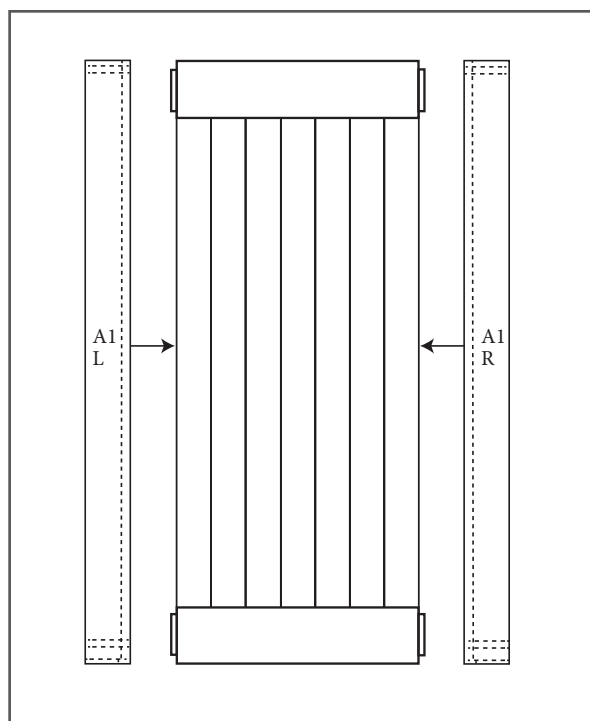

Figure 4

4. Place the left Stile (A1 L) beside the assembled slats and rails. Slide to the right to cover the rail tongues and the edge of the slat assembly. Tap the stile into place with a rubber mallet. Repeat with the right stile (A1 R) (Figure 4).

LEWISTON DOOR Assembly Instructions

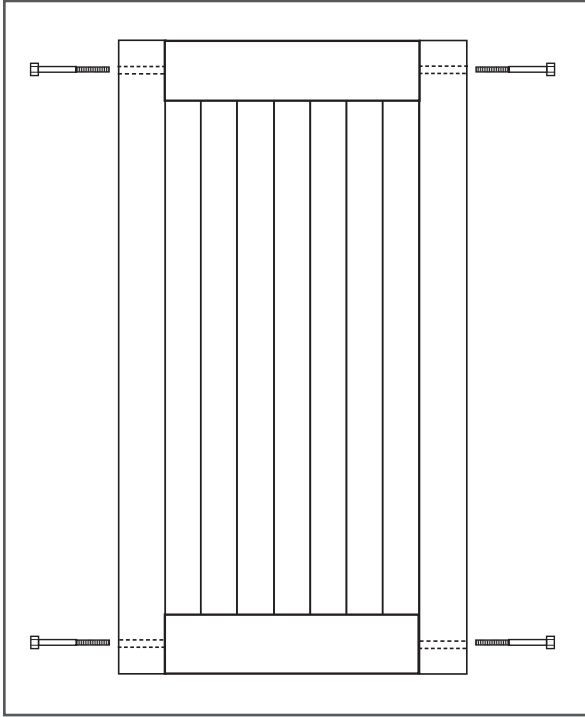

Figure 5

5. Fix the door assembly with four 6" lag bolts (provided), using a socket wrench with a 7/16" socket (Figure 5).

WE LOVE WHAT YOU ARE DOING WITH THE PLACE

**CONGRATULATIONS ON YOUR DECISION TO BRING HOME
AN AMERICAN MADE PRODUCT OF THE HIGHEST QUALITY.
WE HOPE YOUR LEWISTON DOOR BRINGS ART AND FUNCTION INTO
YOUR LIFE.**

**DESIGNED AND CRAFTED
ENTIRELY IN THE**

U.S.A.



**DON'T BE A STRANGER. FOLLOW US
ON SOCIAL MEDIA.**



support@rusticahardware.com